

# Program Memorandum Intermediaries

Department of Health & Human  
Services (DHHS)  
Centers For Medicare & Medicaid  
Services (CMS)

Transmittal A-02-082

Date: AUGUST 21, 2002

CHANGE REQUEST 2322

**SUBJECT: October Outpatient Code Editor (OCE) Specifications Version (V3.2)**

**This Program Memorandum (PM) reflects specifications that were issued for the July revision of the revised OCE (Version V3.1). All redlined material reflects changes that were incorporated into the October version of the OCE.**

**NOTE: OCE version V3.2 refers to the revised OCE that was developed as a result of Outpatient Prospective Payment System (OPPS), and OCE version 18.0 refers to the current version of OCE in place prior to the development of the revised OCE as a result of OPPS. This OCE is referred to as the non-OPPS OCE.**

## Introduction

This PM provides you with the revised OCE instructions and specifications that will be utilized under the OPPS for hospital outpatient departments, community mental health centers (CMHCs), and for limited services as defined below when provided in a comprehensive outpatient rehabilitation facility (CORF), home health agency (HHA) or to a hospice patient for the treatment of a non-terminal illness. This revised version of the OCE represents a significant change to the software in that it will process claims consisting of multiple days of services. You are required, effective with unprocessed claims with dates of service on or after August 1, 2000, to send the following bills through the revised OCE:

- All outpatient hospital Part B bills (bill types 12X, 13X, or 14X) with the exception of Indian Health Service hospitals, critical access hospitals (CAHs), Maryland hospitals, and hospitals located in American Samoa, Guam, and Saipan. In addition, claims from Virgin Island hospitals with dates of service January 1, 2002, and later, **and claims from hospitals that furnish only inpatient Part B services with dates of service January 1, 2003**, and later should not be sent through the revised OCE since they are also excluded from OPPS. (See below for more detail regarding these hospitals.);
- CMHC bills (bill type 76X);
- HHA and CORF bills containing certain Healthcare Common Procedure Coding System (HCPCS) codes as identified in the chart entitled "HCPCS Codes for Reporting Antigenes, Vaccines, Splints and Casts" below (bill types 34X or 75X); and
- Any bill containing a condition code 07 with certain HCPCS codes as identified in the chart entitled "HCPCS Codes for Reporting Antigenes, Vaccines, Splints and Casts" below.

Send all other outpatient bill types (22X, 23X, 24X, 32X, 33X, 71X, 72X, 73X, 74X, 75X, 81X or 82X) with dates of service April 1, 2002, and later, through the revised OPPS OCE. Detailed instructions regarding the routing of **these** claims were provided in PM A-02-026 issued March 28, 2002.

Continue to send Indian Health Service hospitals, CAHs, Maryland hospitals, and hospitals located in American Samoa, Guam, and Saipan through the non-OPPS OCE until further notice. Also send claims from Virgin Island hospitals with dates of service on or after January 1, 2002, **and claims from hospitals that furnish only inpatient Part B services with dates of service on or after January 1, 2003**, through the non-OPPS OCE. **See PM A-02-064 dated July 24, 2002, for more detail regarding hospitals that provide Part B only services to their inpatients.**

**CMS-Pub. 60A**

**NOTE:** For bill type 34X, only vaccines and their administration, splints, casts, and antigens will be paid under OPPS. For bill type 75X, only vaccines and their administration are paid under OPPS. For bills containing condition code 07, only splints, casts and antigens will be paid under OPPS.

You are also required to notify your providers of the OCE claim outputs.

You were provided with the **October** version of the revised OCE that should be installed by **October 1, 2002**.

The following information provides you with the revised OCE edit specifications that will be utilized to make appropriate payments under the OPPS system, which was effective August 1, 2000.

### **General Functions of the OCE**

The revised OCE will perform the following two major functions:

- Edit claims data to identify errors and return a series of edit flags; and
- Assign an ambulatory payment classification (APC) number for each service covered under OPPS and return information to be used as input to the PRICER program.

A major change in processing is required to handle claims with service dates that span more than 1 calendar day. Each claim will be represented by a collection of data, which will consist of all necessary demographic (header) data, plus all services provided (line items). You are responsible for organizing all applicable services into a single claim record, and passing them as a unit to OCE. OCE functions only on a single claim and does not have any cross-claim capabilities. OCE will accept up to 450 line items per claim. The OCE software is responsible for ordering line items by date of service.

The original OCE focused solely on the presence or absence of specific edits and did not specify action that should be taken when an edit occurred (e.g., deny claim, suspend claim). Further, the original OCE did not compute any information that would be used for payment purposes. Therefore, the original OCE was structured to return a set of flags for each diagnosis and procedure that indicated the presence or absence of individual edits. The revised OCE not only identifies individual errors but also indicates actions to take and the reasons why these actions are necessary. In order to accommodate this expanded functionality, the revised OCE is structured to return lists of edit numbers instead of zero/one flags. This new structure facilitates the linkage between the action being taken, the reasons for the action, and the information on the claim (e.g., a specific diagnosis) that caused the action.

In general, OCE performs all functions that require specific reference to HCPCS codes, HCPCS modifiers, and ICD-9-CM diagnosis codes. Since these coding systems are complex and annually updated, the centralization of the direct reference to these codes and modifiers in a single program will reduce effort for you and reduce the chance of inconsistent processing.

The span of time that a claim represents will be controlled by the from and through dates that will be part of the input header information. If the claim spans more than 1 calendar day, OCE will subdivide the claim into separate days for the purpose of determining discounting and multiple visits on the same calendar day.

Some edits will be date driven. For example, bilateral procedure will be considered an error if a pair of procedures is coded with the same service date, but not if the service dates are different.

### **Information Sent to OCE**

Pass header and line items information to the OCE by means of a control block of pointers. Table 1 below contains the structure of the OCE control block. The shaded area separates input from return information. Multiple items are assumed to be in contiguous locations.

The header information must relate to the entire claim and must include the following:

- From date;
- Through date;
- Condition code;
- List of ICD-9-CM diagnosis codes;
- Age;
- Sex;
- Type of bill; and
- Medicare provider number.

The from and through dates will be used to determine if the claim spans more than 1 day and therefore represents multiple visits. The condition code (e.g., 41) specifies special claim conditions such as a claim for partial hospitalization, which is paid on a per diem basis. The diagnosis codes apply to the entire claim and are not specific to a line item. Each line item contains the following information:

- HCPCS code with up to 2 modifiers;
- Revenue code;
- Service date;
- Service units; and
- Charge.

The HCPCS codes and modifiers are used as the basis of assigning the APCs. Not all line items will contain a HCPCS code. The line item service dates are used to subdivide a claim that spans more than 1 day into individual visits. The service units indicate the number of times a HCPCS code was provided (e.g., a lab test with a service unit of 2 means the lab test was performed twice).

### **Information Returned From OCE**

The following is an overview of the information that will be returned from OCE and used as input into the PRICER program.

There are currently 55 different edits in OCE, 2 of which are currently inactive. Each edit is assigned a number. A description of the edits is contained in Table 3. The edit return buffers consist of a list of the edit numbers that occurred for each diagnosis, procedure, modifier, or date. For example, if a 75-year-old male had a diagnosis related to pregnancy, it would create a conflict between the diagnosis and age and sex. Therefore, the diagnosis edit return buffer for the pregnancy diagnosis would contain the edit numbers 2 and 3. There is more space allocated in the edit return buffers than is necessary for the current edits in order to allow future expansion of the number of edits. The four edit return buffers are described in Table 2.

The claim return buffer described in Table 4 summarizes the edits that occurred on the claim. The occurrence of an edit can result in one of six different dispositions.

Claim Rejection	There are one or more edits present that cause the whole claim to be rejected. A claim rejection means that the provider can correct and resubmit the claim but cannot appeal the claim rejection.
Claim Denial	There are one or more edits present that cause the whole claim to be denied. A claim denial means the provider cannot resubmit the claim but can appeal the claim denial.
Claim Return to Provider (RTP)	There are one or more edits present that cause the whole claim to be RTP. A claim RTP means the provider can resubmit the claim once the problems are corrected.
Claim Suspension	There are one or more edits present that cause the whole claim to be suspended. A claim suspension means that the claim is not RTP, but is not processed for payment until you make a determination or obtain further information.

Line Item Rejection	There are one or more edits present that cause one or more individual line items to be rejected. A line item rejection means the claim can be processed for payment with some line items rejected for payment (i.e., the line item can be corrected and resubmitted but cannot be appealed).
Line Item Denials	There are one or more edits present that cause one or more individual line items to be denied. A line item denial means the claim can be processed for payment with some line items denied for payment. The line item cannot be resubmitted but can be appealed. The one exception is for emergency room visits in which a patient dies during a procedure that is categorized as an inpatient procedure. Under such circumstances, the claim can be resubmitted as an inpatient claim.

In the initial release of the OCE, many of the edits have a disposition of RTP in order to give providers time to adapt to OPSS. In subsequent releases of OCE, the disposition of some edits may be changed to other more automatic dispositions such as a line item denial. A single claim can have one or more edits in all six dispositions. Six 0/1 dispositions are contained in the claim return buffer that indicate the presence or absence of edits in each of the six dispositions. In addition, there are six lists of reasons in the claim return buffer that contain the edit numbers that are associated with each disposition. For example, if there were three edits that caused the claim to have a disposition of RTP, the edit numbers of the three edits would be contained in the claim RTP reason list. There is more space allocated in the reason lists than is necessary for the current edits in order to allow for future expansion of the number of edits.

In addition to the six individual dispositions, there is also an overall claim disposition, which summarizes the status of the claim.

Table 5 contains the APC return buffer that contains the APC for each line item along with the relevant information for computing OPSS payment. Two APC numbers are returned: HCPCS APC and payment APC. Except for partial hospitalization claims, the HCPCS APC and the payment APC are always the same. The APC return buffer contains the information that will be passed to the PRICER. The APC is only returned for hospitals and the special conditions specified in "OCE Edits Applied by Bill Type" below. Partial hospitalizations are paid on a per diem basis. There is no HCPCS code that specifies a partial hospitalization related service. Partial hospitalizations are identified by means of a condition code, bill type, and HCPCS codes specifying the individual services that constitute a partial hospitalization. Thus, there are no input line items that directly correspond to the partial hospitalization service. In order to assign the partial hospitalization APC to one of the line items, the payment APC for one of the line items that represents one of the services that comprise partial hospitalization is assigned the partial hospitalization APC.

Observations may be paid separately if they meet specific criteria. (See "OCE Observation Criteria" below.)

Not all edits are performed for all sites of service. See "OCE Edits Applied by Bill Type" below for OCE edits that apply for each bill type.

PRICER computes the standard OPSS payment for a line item as the product of the payment amount corresponding to the assigned payment APC, the discounting factor, and the number of units for all line items for which the following is true:

### **Criteria for Applying Standard OPSS Payment Calculations**

- APC value is not 00000
- Payment indicator has a value of 1
- Packaging flag has a value of zero
- Line item denial or rejection flag is zero or the line item action flag is 1
- Line item action flag is not 2, 3 or 4
- Payment adjustment flag is zero
- Payment method flag is zero

If payment adjustments are applicable to a line item (payment adjustment flag is not 0), then nonstandard calculations are necessary to compute payment for a line item (see Table 6). The line item action flag is passed as input to the OCE as a means of allowing you to override a line item denial or rejection (used by you to override OCE and have PRICER compute payment ignoring the line item rejection or denial) or allowing you to indicate that the line item should be denied or rejected even if there are no OCE edits present. The action flag is also used for handling external line item adjustments. For some sites of service (e.g., HHAs) only some services are paid under OPSS. The line item action flag also impacts the computation of the discounting factor as described under “Computation of Discounting Fraction” below. OPSS payment for the claim is computed as the sum of the payments for each line item with the appropriate conversion factor, wage rate adjustment, outlier adjustment, etc., applied. The OCE overview below summarizes the process of filling in the APC return buffer.

If a claim spans more than 1 day, OCE subdivides the claim into separate days for the purpose of determining discounting and multiple visits on the same day. All claims that span more than 1 day are subdivided into multiple days. Multiple day claims are determined based on calendar day. OCE deals with all multiple day claims issues by means of the return information. PRICER does not need to be aware of the issues associated with multiple day claims. It simply applies the payment computation as described above and the result is the total OPSS payment for the claim regardless of whether the claim was for a single day or multiple days. If a multiple day claim has a subset of the days with a claim denial, RTP, or suspend, the whole claim is denied, RTP, or suspended.

For the purpose of determining the version of the OCE to be applied, the from date on the header information is used.

## Tables

**Table 1: OCE Control Block**

Pointer Name		UB-92 Form Locator	Number	Sizes (bytes)	Flat File	Sizes (bytes)	Comment
Dxptr	ICD-9-CM diagnosis codes	67-75	Up to 15	6	RT70, FL4, RT74, FL12, RT70, FL13, RT70, FL14	9	Diagnosis codes apply to whole claim and are not specific to a line item (left justified, blank filled). First listed diagnosis is considered “reason for visit diagnosis”
Ndxptr	Count of the number of diagnoses pointed to by Dxptr		1	4			Binary fullword count
Sgptr	Line item entries	44-46	Up to 450		RT61 FL6-9 FL11-13	44	
Nsgptr	Count of the number of Line item entries pointed to by Sgptr		1	4			Binary fullword count
Flagptr	Line item action flag. Flag sent by you and passed by OCE to PRICER		Up to 450	1			(See table 7)
Ageptr	Numeric age in years		1	3			0-124
Sexptr	Numeric sex code	15	1	1	RT30 FL15		0, 1, 2, (unknown, male, female)
Dateptr	From and Through dates (yyyymmdd)	6	2	8	RT20 FL19-20	16	Used to determine multi-day claim
CCptr	Condition codes	24-30	Up to 7	2	RT41 FL4-13	20	Used to identify partial hospitalization and hospice
NCCptr	Count of the number of condition codes entered		1	4			Binary fullword count
Billptr	Type of bill	4	1	3	RT40, FL4	3	Used to identify CMHCs and claims pending under OPSS. It is presumed that bill type has been edited for validity by the standard system before that claim is sent to OCE

Pointer Name		UB-92 Form Locator	Number	Sizes (bytes)	Flat File	Sizes (bytes)	Comment
National Provider Identifier (NPI) Provptr	NPI Medicare Provider Number	51	1	13	RT10, FL6, RT30, FL24	13	Pass on to PRICER
OSCAR Provptr	OSCAR Medicare Provider Number	51	1	6	RT10, FL6, RT30, FL24	6	Pass on to PRICER
PstatPtr	Patient status	22	1	2	RT 20, FL12-16		For future use
OppsPtr	Opps/Non-OPPS flag		1	1			1=OPPS, 2=Non-OPPS (For future use)
Dxeditptr	Diagnosis edit return buffer		Up to 15	Table 2			Count specified in Ndxptr
Proceditptr	Procedure edit return buffer		Up to 450	Table 2			Count specified in Nsgptr
Mdeditptr	Modifier edit return buffer		Up to 450	Table 2			Count specified in Nsgptr
Dteditptr	Date edit return buffer		Up to 450	Table 2			Count specified in Nsgptr
Rceditptr	Revenue code edit return buffer		Up to 450	Table 2			Count specified in Nsgptr
APCptr	APC return buffer		Up to 450	Table 5			Count specified in Nsgptr
Claimptr	Claim return buffer		1	Table 4			
Wkptr	Work area pointer		1	256K			Working storage allocated in user interface
Wklenptr	Actual length of the work area pointed to by Wkptr		1	4			Binary fullword

For those using X12N 837 formats, the following is provided to assist in your implementation efforts:

The Medicare A 837 Health Care Claim version 3051 implementations 3A.01 and 1A.C1 (Appendix C of both documents have UB-92 mapping), along with the UB-92 version 6.0 are at [www.hcfa.gov/medicare/edi/edi3.htm](http://www.hcfa.gov/medicare/edi/edi3.htm). These formats are effective through October 16, 2003. The X12N 837 version 4010 (HIPAA) to UB-92 version 6.0 mapping is at <http://www.hcfa.gov/medicare/edi/hipaadoc.htm>. The 837 version 4010 can be downloaded at [www.wpc-edi.com](http://www.wpc-edi.com).

**Table 2: Edit Return Buffers**

Name	Size (bytes)	Number	Values	Description	Comments
Diagnosis edit return buffer	2	8	0-5	Two-digit code specifying the edits that apply to the diagnosis. Currently, there are five different edits that apply to diagnoses	There is one 8x2-diagnosis edit return buffer for each of up to 15 diagnoses.
Procedure edit return buffer	2	30	0,6,8-9, 12-21, 28,37-40,42-45,47, 49-50, 52-55	Two-digit code specifying the edits that apply to the procedure. Currently, there are 29 active edits that apply to procedures	There is one 30x2 procedure edit return buffer for each of up to 450 line items.
Modifier edit return buffer	2	4	0,22	Two-digit code specifying the edits that apply to the modifier. Currently, there is 1 edit that applies to modifiers	There is one 4x2 modifier edit return buffer for each of the five <u>modifiers</u> for each of up to 450 line items.
Date edit return buffer	2	4	0,23	Two-digit code specifying the edits that apply to the line item dates. Currently, there is one edit that applies to dates	There is one 4x2 date edit return buffer for each of up to 450 line items.
Revenue Center edit return buffer	2	5	0,41,48	Two-digit code specifying the edits that apply to revenue centers. Currently, there are two edits that apply to revenue centers	There is one 5x2 revenue center edit return buffer for each of up to 450 line items

Each of the return buffers is positionally representative of the source that it contains information for, in the order in which that source was passed to OCE. For example, the seventh diagnosis return buffer contains information about the seventh diagnosis; the fourth modifier edit buffer contains information about the modifiers in the fourth line item.

**Table 3: Description of Edits/Claim Reasons**

<b>Edit</b>	<b>Description</b>	<b>Disposition</b>
1	Invalid diagnosis code	RTP
2	Diagnosis and age conflict	RTP
3	Diagnosis and sex conflict	RTP
4	Medicare secondary payer alert (V1.0 and V1.1 only)	Suspend
5	E-diagnosis code can not be used as principle diagnosis	RTP
6	Invalid procedure code	RTP
7	Procedure and age conflict <b>(Not activated)</b>	RTP
8	Procedure and sex conflict	RTP
9	Non-covered for reasons other than statute	Line item denial
10	Service submitted for verification of denial (condition code 21)	Claim denial
11	Service submitted for review (condition code 20)	Suspend
12	Questionable covered service	Suspend
13	Separate payment for services is not provided by Medicare	Line item rejection
14	Code indicates a site of service not included in OPPS	RTP
15	Service unit out of range for procedure (V1.0 through V2.2 only)	RTP
16	Multiple bilateral procedures without modifier 50 (see Table 7)	RTP
17	Inappropriate specification of bilateral procedure (see Table 7)	RTP
18	Inpatient procedure	Line item denial (**)
19	Mutually exclusive procedure that is not allowed by CCI even if appropriate modifier is present	Line item rejection
20	Component of a comprehensive procedure that is not allowed by CCI even if appropriate modifier is present	Line item rejection
21	Medical visit on same day as a type "T" or "S" procedure without modifier 25 (see "Multiple Medical and Procedure Visits on the Same Day" below)	Line item rejection
22	Invalid modifier	RTP
23	Invalid date	RTP
24	Date out of OCE range	Suspend
25	Invalid age	RTP
26	Invalid sex	RTP
27	Only incidental services reported	RTP
28	Code not recognized by Medicare; alternate code for same service may be available	RTP

<b>Edit</b>	<b>Description</b>	<b>Disposition</b>
	(See Partial Hospitalization/Mental Health Logic Charts for logic of edits 29-36)	
29	Partial hospitalization service for non-mental health diagnosis	RTP
30	Insufficient services on day of partial hospitalization	Suspend
31	Partial hospitalization on same day as electroconvulsive therapy or type T procedure	Suspend
32	Partial hospitalization claim spans 3 or less days with insufficient services, or electroconvulsive therapy or significant procedure on at least one of the days	Suspend
33	Partial hospitalization claim spans more than 3 days with insufficient number of days having mental health services	Suspend
34	Partial hospitalization claim spans more than 3 days with insufficient number of days meeting partial hospitalization criteria	Suspend
35	Only activity therapy and/or occupational therapy services provided	RTP
36	Extensive mental health services provided on day of electroconvulsive therapy or significant procedure	Suspend
37	Terminated bilateral procedure or terminated procedure with units greater than one	RTP
38	Inconsistency between implanted device and implantation procedure	RTP
39	Mutually exclusive procedure that would be allowed by CCI if appropriate modifier were present	Line rejection item
40	Component of a comprehensive procedure that would be allowed by CCI if appropriate modifier were present	Line rejection item
41	Invalid revenue code	RTP
42	Multiple medical visits on same day with same revenue code without condition code G0 (See "Rules for Medical and Procedure Visits on Same Day and for Multiple Medical Visits on Same Day")	RTP
43	Transfusion or blood product exchange without specification of blood product	RTP
44	Observation revenue code on line item with non-observation HCPCS code	RTP
45	Inpatient separate procedures not paid	Line rejection item
46	Partial hospitalization condition code 41 not approved for type of bill	RTP
47	Service is not separately payable	Line rejection item
48	Revenue center requires HCPCS	RTP
49	Service on same day as inpatient procedure	Line item denial
50	Non-covered based on statutory exclusion	Line rejection item
51	Multiple observations overlap in time <b>(Not activated)</b>	RTP
52	Observation does not meet criteria for separate payment	RTP
53	Code G0244 is only allowed with bill type 13X	Line rejection item
54	Multiple codes for the same service	RTP
55	Non-reportable for site of service	RTP

(\*\*) Edit 18 will cause all other line items on the same day to be line item denied with Edit 49 (see Table 5 "Line item denial or reject flag".) No other edits are performed on any lines with Edit 18 or 49.

If Edit 27 is triggered, no other edits are performed on the claim.

**Table 4: Claim Return Buffer**



Name	Size (bytes)	Number	Values	Description
Claim processed flag	1	1	0-3, 9	0- Claim processed 1-Claim could not be processed (edits 23 or 24 or invalid bill type) 2-Claim could not be processed (claim has no line items) 3-Claim could not be processed (Condition Code 21 present) 9- Fatal error, OCE can not run – the environment can not be set up as needed. Exit immediately.
Number of line items	3	1	nnn	Input value from Nsgptr, or 450, whichever is less
NPI	13	1	aaaaaaaaaaaa	Transferred from input, for PRICER
OSCAR Medicare provider number	6	1	aaaaaa	Transferred from input, for PRICER
Overall claim disposition	1	1	0-5	0- No edits present on claim 1- Only edits present are for line item denial or rejection 2- Multiple-day claim with one or more days denied or rejected 3- Claim denied, rejected, suspended or RTP, or single day claim with all line items denied or rejected, with only post-payment edits 4- Claim denied, rejected, suspended or RTP, or single day claim with all line items denied or rejected, with only pre-payment edits 5- Claim denied, rejected, suspended or RTP, or single day claim with all line items denied or rejected, with both post-payment and pre-payment edits
Claim rejection disposition	1	1	0-2	0- Claim not rejected 1- There are one or more edits present that cause the claim to be rejected 2- There are one or more edits present that cause one or more days of a multiple-day claim to be rejected
Claim denial disposition	1	1	0-2	0- Claim not denied 1- There are one or more edits present that cause the claim to be denied 2- There are one or more edits present that cause one or more days of a multiple-day claim to be denied, or single day claim with all lines denied (edit 18 only).
Claim RTP disposition	1	1	0-1	0- Claim not RTP 1- There are one or more edits present that cause the claim to be RTP
Claim suspension disposition	1	1	0-1	0- Claim not suspended 1- There are one or more edits present that cause the claim to be suspended
Line item rejection disposition	1	1	0-1	0- There are no line item rejections 1- There are one or more edits present that cause one or more line items to be rejected
Line item denial disposition	1	1	0-1	0- There are no line item denials 1- There are one or more edits present that cause one or more line items to be denied
Claim rejection reasons	2	4		Two digit code specifying edits that caused the claim to be rejected. There are currently no edits that cause a claim to be rejected
Claim denial reasons	2	8	10	Two digit code specifying edits that caused the claim to be denied There is currently 1 edit that causes a claim to be denied
Claim RTP reasons	2	30	1-3, 5-6, 8, 14-17, 22, 23, 25-29, 35, 37, 38, 41-44, 46, 48, 52, 54, 55	Two-digit code specifying edits that caused the claim to be RTP There are currently 29 different active edits that cause a claim to be RTP
Claim suspension reasons	2	16	4, 11, 12, 24, 30-34, 36	Two-digit code specifying the edits that caused the claim to be suspended There are currently 10 different edits that cause a claim to be suspended
Line item rejection reasons	2	12	13, 19, 20, 21, 39, 40, 45, 47, 50, 53	Two digit code specifying the edits that caused the line item to be rejected There are currently 10 edits that cause a line item to be rejected
Line item denied reasons	2	6	9, 18, 49	Two-digit code specifying the edits that caused the line item to be denied There are currently 3 edits that cause a line item denial
APC return buffer flag	1	1	0-1	0-No services paid under OPPTS. APC return buffer filled in with default values (See "OCE Edits Applied by Bill Type") 1-One or more services paid under OPPTS. APC return buffer filled in
Version Used	8	1	yy.vv.rr	Version ID of the version used for processing the claim (e.g., 2.1.0)
Patient Status	2	1		Patient status code – transferred from input
OPPS Flag	1	1	0-1	OPPS/Non-OPPS flag – transferred from input

**Table 5: APC Return Buffer**

Names	Size (bytes)	Values	Description
HCPCS procedure code	5	Alpha	For potential future use by PRICER Transfer from input
Payment APC	5	0001-nnnnn	APC used to determine payment. If no APC assigned to line item, the value 00000 is assigned. For partial hospitalization claims the payment APC may be different than the APC assigned to the HCPCS code.
HCPCS APC	5	0001-nnnnn	APC assigned to HCPCS code.
Service indicator	1	Alpha	A-Services not paid under OPPS B-Non-allowed item or service for OPPS C- Inpatient procedure E- Non allowed item or service F- Corneal tissue acquisition G- Drug/Biological Pass-through H- Device pass-through J- New drug or new biological pass-through* K-Non pass-through drug or device N- Packaged incidental service P- Partial hospitalization service S- Significant procedure not subject to multiple procedure discounting T- Significant procedure subject to multiple procedure discounting V- Medical visit to clinic or emergency department X- Ancillary service
Payment indicator	1	Alpha-numeric	1- Paid standard hospital OPPS amount (service indicators K, S, T, V, X) 2- Services not paid under OPPS (service indicator A, or no HCPCS code and not certain revenue codes) 3- Not paid, or not paid under OPPS (service indicators B, C, E) 4- Paid at reasonable cost (service indicator F) 5- Additional payment for drug or biological (service indicator G) 6- Additional payment for device (service indicator H) 7- Additional payment for new drug or new biological (service indicator J) * 8- Paid partial hospitalization per diem (service indicator P) 9- No additional payment, payment included in line items with APCs (service indicator N, or no HCPCS code and certain revenue codes, or HCPCS codes G0176 (activity therapy), G0129 (occupational therapy) or G0177 (partial hospitalization program services)) See Partial Hospitalization Logic on page 18 for detailed information.
Discounting formula number	1	1-8	See "Computation of Discounting Fraction" for values
Line item denial or rejection flag	1	0-2	0- Line item not denied or rejected 1- Line item denied or rejected (procedure edit return buffer for line item contains a 9, 13, 18, 19, 20, 21, 39, 40, 45, 47, 49, 50, 53) 2-The line item has no errors, but occurs on a day that has been denied or rejected (not used as of 4/1/02 - v3.0).
Packaging flag	1	0-2	0- Not packaged 1- Packaged service (service indicator N) 2- Packaged as part of partial hospitalization per diem or daily mental health service per diem
Payment adjustment flag	1	0-4	0- No payment adjustment 1- Additional payment for drug or biological applies to APC (service indicator G) 2- Additional payment for device applies to APC (service indicator H) 3- Additional payment for new drug or new biological applies to APC (service indicator J)* 4- Deductible not applicable (specific list of HCPCS codes)
Payment Method Flag	1	0-4	0-OPPS PRICER determines payment for service 1-Based on OPPS or coverage rules, the service is not paid 2-Service is not subject to OPPS 3-Service is not subject to OPPS, and has an OCE line item denial or rejection 4-Line item is denied or rejected by you; OCE not applied to line item
Service Units	7	1-x	Transferred from input, for PRICER. For the line items assigned APCs 33 or 34, the service units are always assigned a value of one by the OCE even if the input service units were greater than one.
Charge	10	nnnnnnnnn	Transferred from input, for PRICER
Line item action flag	1	0-4	Transferred from input, for PRICER, and can impact selection of discounting formula 0-OCE line item denial or rejection is not ignored 1-OCE line item denial or rejection is ignored

Names	Size (bytes)	Values	Description
			2-External line item denial. Line item is denied even if no OCE edits 3-External line item rejection. Line item is rejected even if no OCE edits. 4-External line item adjustment. Technical charge rules apply.

\* Service indicator J was replaced by service indicator G starting in April 2002 (V3.0)

**Table 6: Criteria for Payment Adjustment Flag**

The payment adjustment flag for a line item (See Table 5) is set based on the criteria in the following chart:

Criteria	Payment Adjustment Flag Value
Service indicator G	1
Service indicator H	2
Service indicator J*	3
Code is flagged as 'deductible not applicable'	4
All others	0

\* Service indicator J was replaced by service indicator G starting in April 2002 (V3.0)

**Table 7: Bilateral Procedure Logic**

There is a list of codes that are exclusively bilateral if a modifier of 50 is present. The following edits apply to these bilateral procedures.

Condition	Action	Edit
The same code which can be performed bilaterally occurs two or more times on the same date of service, all codes without a 50 modifier	RTP	16
The same code which can be performed bilaterally occurs two or more times (based on units and/or lines) on the same date of service, all or some codes with a 50 modifier	RTP	17

In addition, there is a list of codes that are considered inherently bilateral even if a modifier of 50 is not present. The following edit applies to these bilateral procedures.

Condition	Action	Edit
The same bilateral code occurs two or more times (based on units and/or lines) on the same date of service	RTP	17

**NOTE:** For ER and observation claims, all services on the claim are treated like any normal claim, including multiple day processing.

### **Rules for Medical and Procedure Visits on the Same Day and for Multiple Medical Visits on the Same Day**

Under some circumstances, medical visits on the same date as a procedure will result in additional payments. A modifier of 25 with an Evaluation and Management (E&M) (service indicator V) code is used to indicate that a medical visit was unrelated to any procedure that was performed with a type of T or S. E&M codes on the same day and same claim as a procedure of type T or S will have the medical APC assigned to all lines with E&M codes. However, if any E&M code that occurs on a claim with a type T or S procedure does not have a modifier of 25, then edit 21 will apply and there will be a line item rejection.

If there are multiple E&M codes on the same day on the same claim, the rules associated with multiple visits are shown in the following table.

E&M	Revenue Center	Condition Code	Action	Edit
-----	----------------	----------------	--------	------

<b>E&amp;M</b>	<b>Revenue Center</b>	<b>Condition Code</b>	<b>Action</b>	<b>Edit</b>
2 or more	Revenue center is different for each E&M code, and all E&M codes have units equal to 1	Not G0	Assign medical APC to each line item with E&M code	-
2 or more	Two or more E&M codes have the same revenue center  OR One or more E&M codes with units greater than 1 had same revenue center	Not G0	Assign medical APC to each line item with E&M code and RTP	Edit 42
2 or more	Two or more E&M codes have the same revenue center  OR One or more E&M codes with units greater than 1 had same revenue center	G0	Assign medical APC to each line item with E&M code	-

Condition code G0 specifies that multiple medical visits occurred on the same day with the same revenue center, and these visits were distinct and constituted independent visits (e.g., two visits to the ER, one for a broken arm and one for chest pain).

### **Computation of Discounting Fraction**

Line items with a service indicator of “T” are subject to multiple procedure discounting unless modifiers 76, 77, 78 and/or 79 are present. The “T” line item with the highest payment amount will not be multiple procedure discounted, and all other “T” line items will be multiple procedure discounted. All line items that do not have a service indicator of “T” will be ignored in determining the discount. A modifier of 73 indicates that a procedure was terminated prior to anesthesia. A terminated procedure will also be discounted although not necessarily at the same level as the discount for multiple type “T” procedures. Terminated bilateral procedures or terminated procedures with units greater than one for type “T” procedures should not occur and have the discounting factor set so as to result in the equivalent of a single procedure. Bilateral procedures are identified from the “bilateral” field in the physician fee schedule. For non-type “T” procedures there is no terminated procedure or multiple bilateral discounting performed. Bilateral procedures have the following values in the “bilateral” field:

1. Conditional bilateral (i.e., procedure is considered bilateral if the modifier 50 is present);
2. Inherent bilateral (i.e., procedure in and of itself is bilateral); and
3. Independent bilateral (i.e., procedure is considered a bilateral if the modifier 50 is present, but full payment should be made for each procedure (e.g., certain radiological procedures))

Inherent bilateral procedures will be treated as a non-bilateral procedure since the bilaterality of the procedure is encompassed in the code. For bilateral procedures the type “T” procedure discounting rules will take precedence over the discounting specified in the physician fee schedule. All line items for which the line item denial or reject indicator is 1 and the line item action flag is zero, or the line item action flag is 2, 3 or 4 will be ignored in determining the discount.

The discounting process will utilize an APC payment amount file. The discounting factor for bilateral procedures is the same as the discounting factor for multiple type “T” procedures.

There are eight different discount formulas that can be applied to a line item.

1. 1.0
2.  $(1.0+D(U-1))/U$
3. T/U
4.  $(1+D)/U$
5. D

6. TD/U
7. D(1+D)/U
8. 2.0

Where

**D** = discounting fraction (currently 0.5)  
**U** = number of units  
**T** = terminated procedure discount (currently 0.5)

The discount formula, which applies is summarized in the following table.

			Discounting Formula Number			
			Type "T" Procedure		Non Type "T" Procedure	
Payment Amount	Modifier 73	Modifier 50	Conditional or Independent Bilateral	Inherent or Non-Bilateral	Conditional or Independent Bilateral	Inherent or Non Bilateral
Highest	No	No	2	2	1	1
Highest	Yes	No	3	3	1	1
Highest	No	Yes	4	2	8	1
Highest	Yes	Yes	3	3	+8	1
Not Highest	No	No	5	5	1	1
Not Highest	Yes	No	6	6	1	1
Not Highest	No	Yes	7	5	8	1
Not Highest	Yes	Yes	6	6	+8	1

For the purpose of determining which APC has the highest payment amount, the terminated procedure discount (**T**) will be applied prior to selecting the type T procedure with the highest payment amount.

List of HCPCS codes in the following chart specify vaccines, antigens, splints, and casts.

### **HCPCS Codes for Reporting Antigens, Vaccines, Splints, and Casts**

Category	Code
Antigens	95144, 95145, 95146, 95147, 95148, 95149, 95165, 95170, 95180, 95199
Vaccines	90657, 90658, 90659, 90723, 90732, 90740, 90743, 90744, 90746, 90747, 90748, G0008, G0009, G0010
Splints	29105, 29125, 29126, 29130, 29131, 29505, 29515
Casts	29000, 29010, 29015, 29020, 29025, 29035, 29040, 29044, 29046, 29049, 29055, 29058, 29065, 29075, 29085, 29305, 29325, 29345, 29355, 29358, 29365, 29405, 29425, 29435, 29440, 29445, 29450, 29700, 29705, 29710, 29715, 29720, 29730, 29740, 29750, 29799

### **Correct Coding Initiative (CCI) Edits**

OCE will generate CCI edits. All CCI edits will be incorporated in the OCE with the exception of anesthesiology edits, E&M, mental health, and dermabond.

The CCI edits are applicable to claims submitted on behalf of the same beneficiary, provided by the same provider, and on the same date of service. The edits are of two major types of coding situations. One type, referred to as the comprehensive/component edits, are those edits which are applied to code combinations where one of the codes is a component of the more comprehensive code. In this instance only the comprehensive code is paid. The other type, referred to as the mutually exclusive edits, are those edits which are applied to code combinations where one of the codes is considered to be either impossible or improbable to be performed with the other code. Other unacceptable code combinations are also included. One such code combination consists of one code that represents a service 'with' something and the other is 'without' the something. The edit is set to pay the lesser-priced service.

**Version 8.2** of CCI edits is included in the **October** OCE. Note that the CCI edits in the OCE are always one quarter behind the Carrier CCI edits.

See chart "OCE Edits Applied by Bill Type" for bill types which the OCE will subject to these and other OCE edits.

### **Unit of Service Edits**

OCE edit 15 "Service Unit Out of Range for Procedure" has not been revised for this version of the OCE. Therefore, the moratorium on the application of edit 15 has been extended until further notice.

OCE Edits Applied by Bill Type

Flow Chart Cell (*)	Provider/Bill Types	DX & Proc (1-5, 7-9, 11-12, 50, 53, (**), 54)	HCPC (6,13)	OPP S Site of svc (14)	Non Medicare Code (28)	Proc & Modifier (18,38, 43,45,47, 49)	HCPC Req'd (48)	Modifier (16,17, (**), 22,37)	CCI (19, 20, 39, 40)	Units (15)	(*) Line Item Date (23)	Rev Code (41, 44)	Age, Sex (25, 26)	Partial Hosp (29-34)	APC (21, 27, 42)	MH (35, 36)	Bill Type (46)	APC buffer Completed	Observation Logic (51, 52)	OPPS Proc (55)
1	12X or 14X w condition code 41	N	N	N	N	N	N	N	N	N	N	N	N	N	N	N	Y	N	N	N
2	12X, or 14X w.o condition code 41	Y	Y	Y	Y	Y	Y	Y	Y	Y	Y	Y	Y	N	Y	Y	N	Y	N	N
3	13X w condition code 41	Y	Y	Y	Y	Y	Y	Y	Y	Y	Y	Y	Y	Y	Y	N	N	Y	Y	N
4	13X w.o condition code 41	Y	Y	Y	Y	Y	Y	Y	Y	Y	Y	Y	Y	N	Y	Y	N	Y	Y	N
5	76X (CMHC)	Y	Y	N	Y	Y	Y	N	N	Y	Y	Y	Y	Y	N	N	N	Y	N	Y
6	34X (HHA) w Vaccine, Antigen, Splint or Cast	Y	Y	N	Y	Y	N	N	N	Y	N	Y	Y	N	N	N	N	Y	N	Y
7	34X (HHA) w.o Vaccine, Antigen, Splint or Cast	Y	Y	N	Y	N	N	N	N	N	N	Y	Y	N	N	N	N	N	N	Y
8	75X (CORF) w Vaccine (PPS)	Y	Y	N	Y	Y	Y	N	N	Y	N	Y	Y	N	N	N	N	Y	N	Y
9	Any bill type with the exception of 12X,13X,14X, 76X, 34X, or (75X with Vaccine) w condition code 07 w Antigen, Splint or Cast	Y	Y	N	Y	Y	N	N	N	N	Y	Y	Y	N	N	N	N	N	Y	Y
10	75X (CORFs) w.o Vaccine	Y	Y	N	Y	N	Y	N	N	Y	Y	Y	Y	N	N	N	N	N	N	Y
11	22X,23X (SNF), 24X	Y	Y	N	Y	N	N	N	N	N	Y	Y	Y	N	N	N	N	N	N	Y
12	32X, 33X (HHA)	Y	N	N	N	N	N	N	N	N	N	Y	Y	N	N	N	N	N	N	Y
13	71X (RHC), 73X (FQHC)	Y	N	N	N	N	N	N	N	N	N	Y	Y	N	N	N	N	N	N	Y
14	72X (ESRD)	Y	N	N	N	N	N	N	N	N	N	Y	Y	N	N	N	N	N	N	Y
15	74X (OPTs)	Y	Y	N	Y	N	Y	N	N	N	N	Y	Y	N	N	N	N	N	N	Y
16	81X (Hospice), 82X	Y	N	N	N	N	N	N	N	N	N	Y	Y	N	N	N	N	N	N	Y

(\*) FLOW CHART CELLS ARE IN HIERARCHICAL ORDER Y=edits apply, N=edits do not apply

Edit 10, and Edits 23 and 24 for From/Through dates, are not dependent on this chart

(\*) if edit 23 is not applied (N), the lowest service (or From) date is substituted for any invalid dates, and processing continues.

(\*\*) Bypass edit 22 if Revenue code is 540

(\*\*\*) Edit 53 not relevant for bill type 13X

**Flow Chart for OCE Edits Applied by Bill Type**

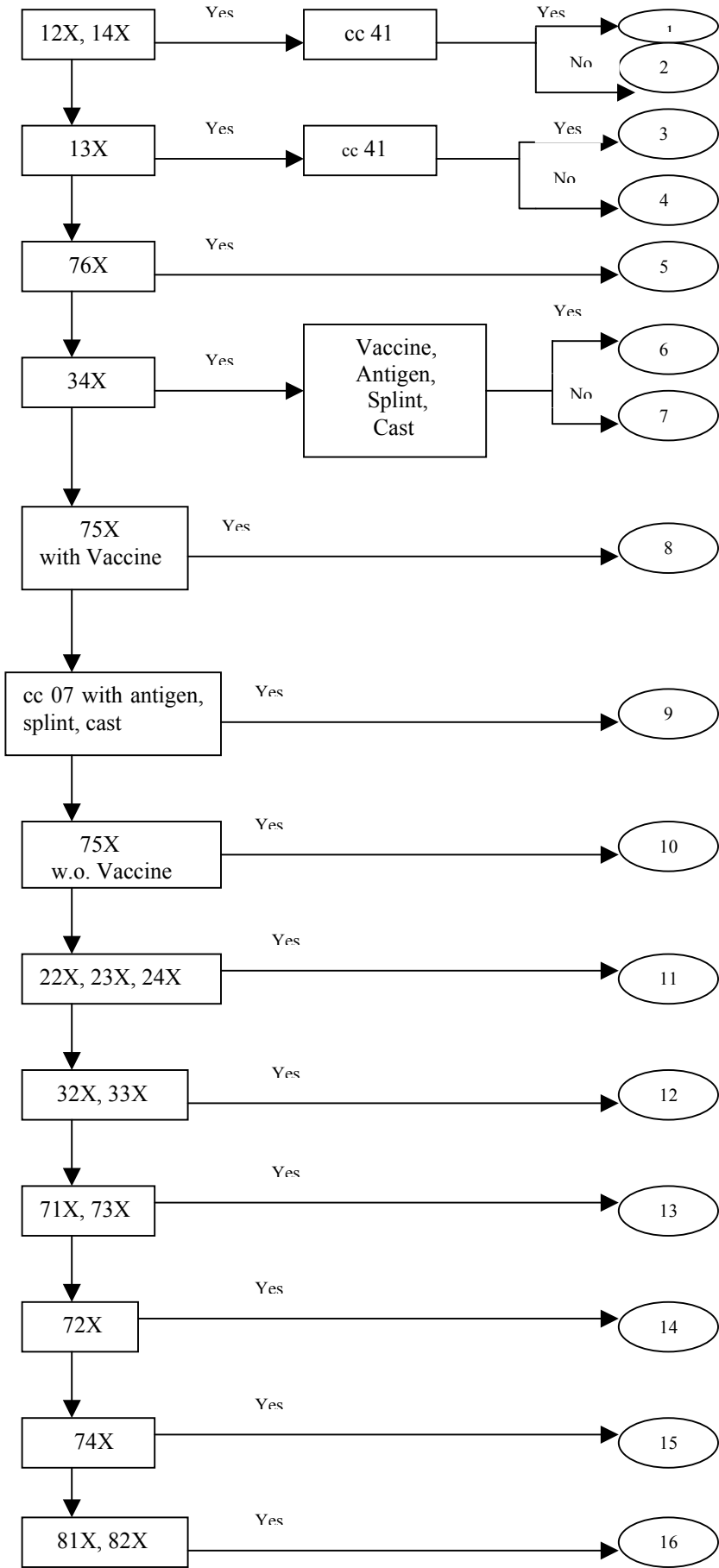



## Partial Hospitalization Logic

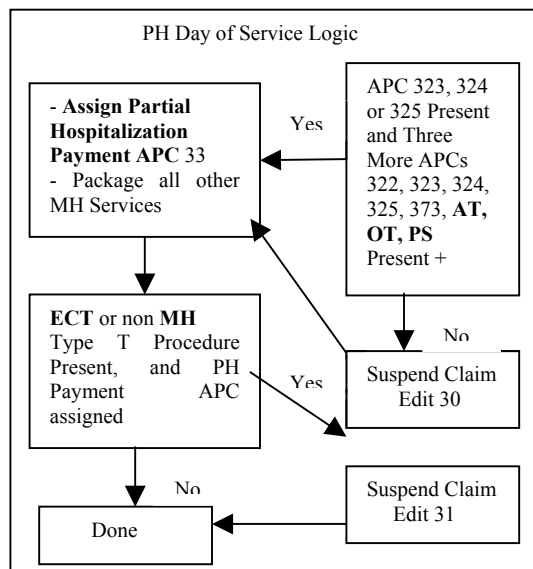

PH = Partial Hospitalization (APC 33)  
 MH = Mental Health (APC 322-5, 373-4)  
 ECT = Electroconvulsive Therapy (APC 320)  
 AT = Activity Therapy (HCPCS code G0176)  
 OT = PH Occupational Therapy (HCPCS code G0129)  
 PS = PH Program Services (HCPCS code G0177)

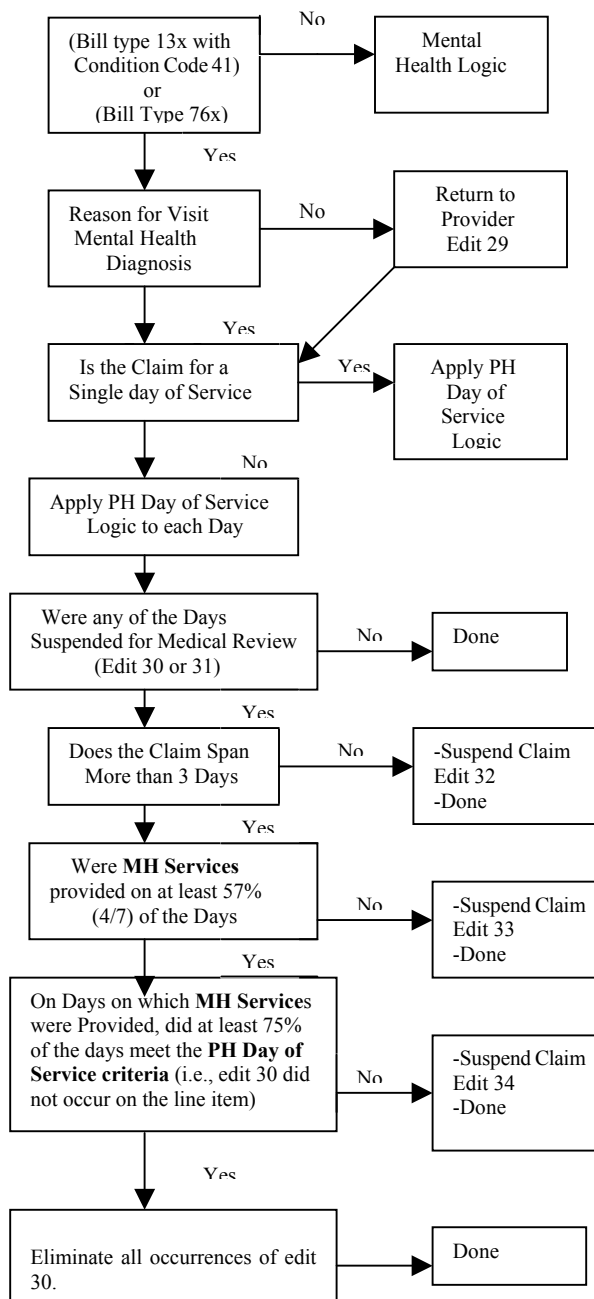
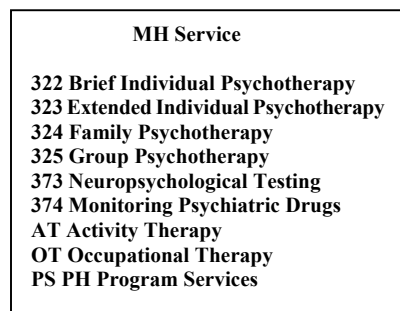

+Multiple occurrences of 322, 323, 324, 325, and 373 are treated as separate APCs in determining whether 3 or more APCs are present. However, multiple occurrences of AT, multiple occurrences of OT, and multiple occurrences of PS are each treated as a single APC.

### Assign Partial Hospitalization Payment APC

For any day that has an MH Service, the first listed line item with HCPCS APC from the hierarchical list of APCs (323, 324, 325, 322, 373, 374, AT, OT, PS) is assigned a payment APC of 33, a service indicator of P, a payment indicator of 8, a discounting factor of 1, a line item denial or rejection indicator of 0, a packaging flag of 0, a payment adjustment flag of 0, and a service unit of 1.

For all other line items with a mental health service (i.e., 322, 323, 324, 325, 373, 374, AT, OT or PS) the packaging flag is set to 2.

## Mental Health Logic

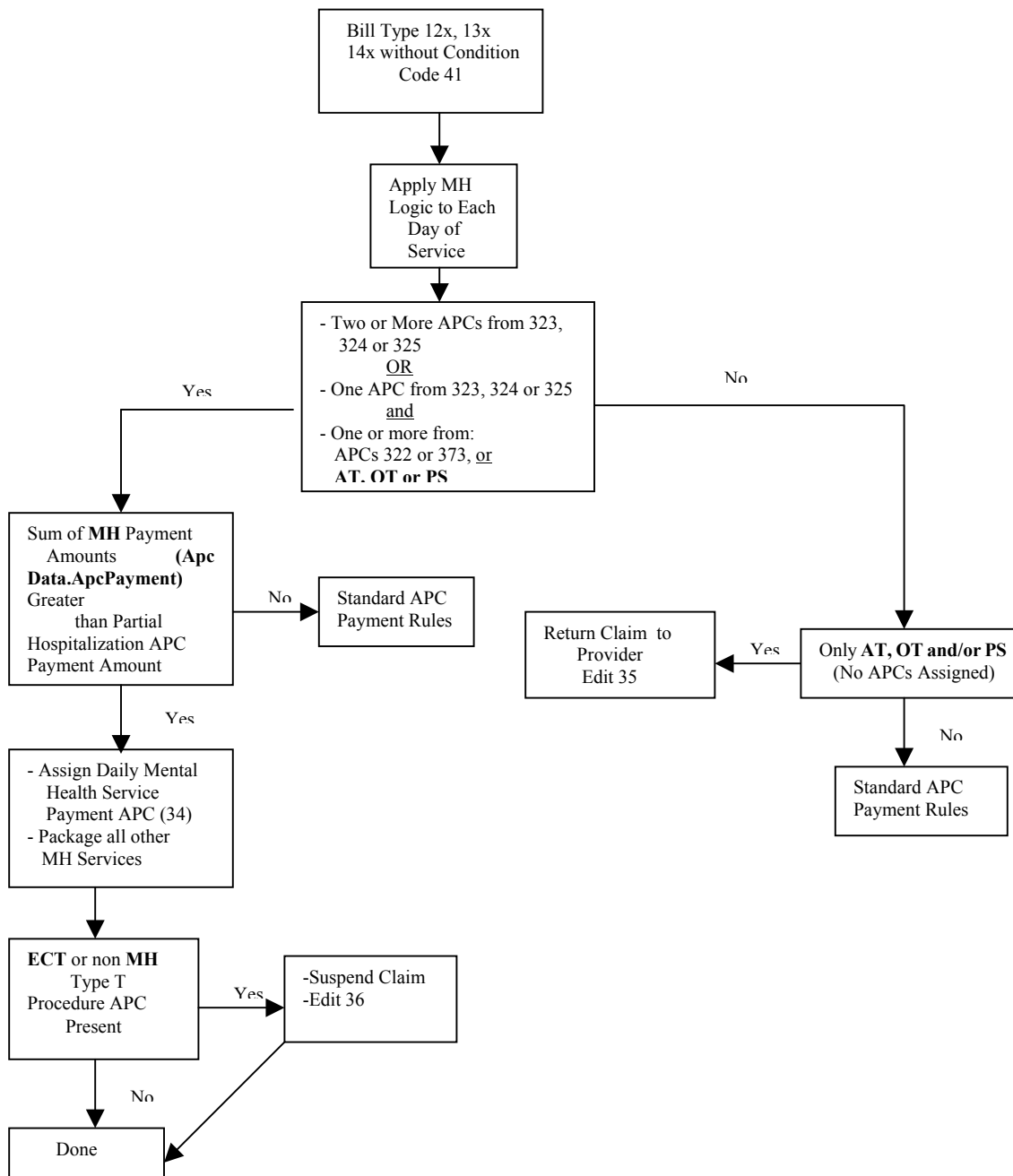

### Assign Daily Mental Health Service Payment APC

The first listed line item with HCPCS APC from the hierarchical list of APCs (323, 324, 325) is assigned a payment APC of 34, a service indicator of P, a payment indicator of 8, a discounting factor of 1, a line item denial or rejection indicator of 0, a packaging flag of 0, a payment adjustment flag of 0 and a service unit of 1.

For all other line items with a mental health HCPCS APC (i.e., 322, 323, 324, 325, 373, 374 AT, OT, PS) the packaging flag is set to 2.

**Logic for Assigning Payment Method Flag Values to a Line**

**Payment Method Flag (PMF)**

- 0-OPPS PRICER determines payment for service
- 1- Based on OPPS or coverage rules service is not paid
- 2- Service is not subject to OPPS
- 3- Service not subject to OPPS with an OCE line item denial or rejection
- 4- Line item denied or rejected by FI. OCE not applied to line item

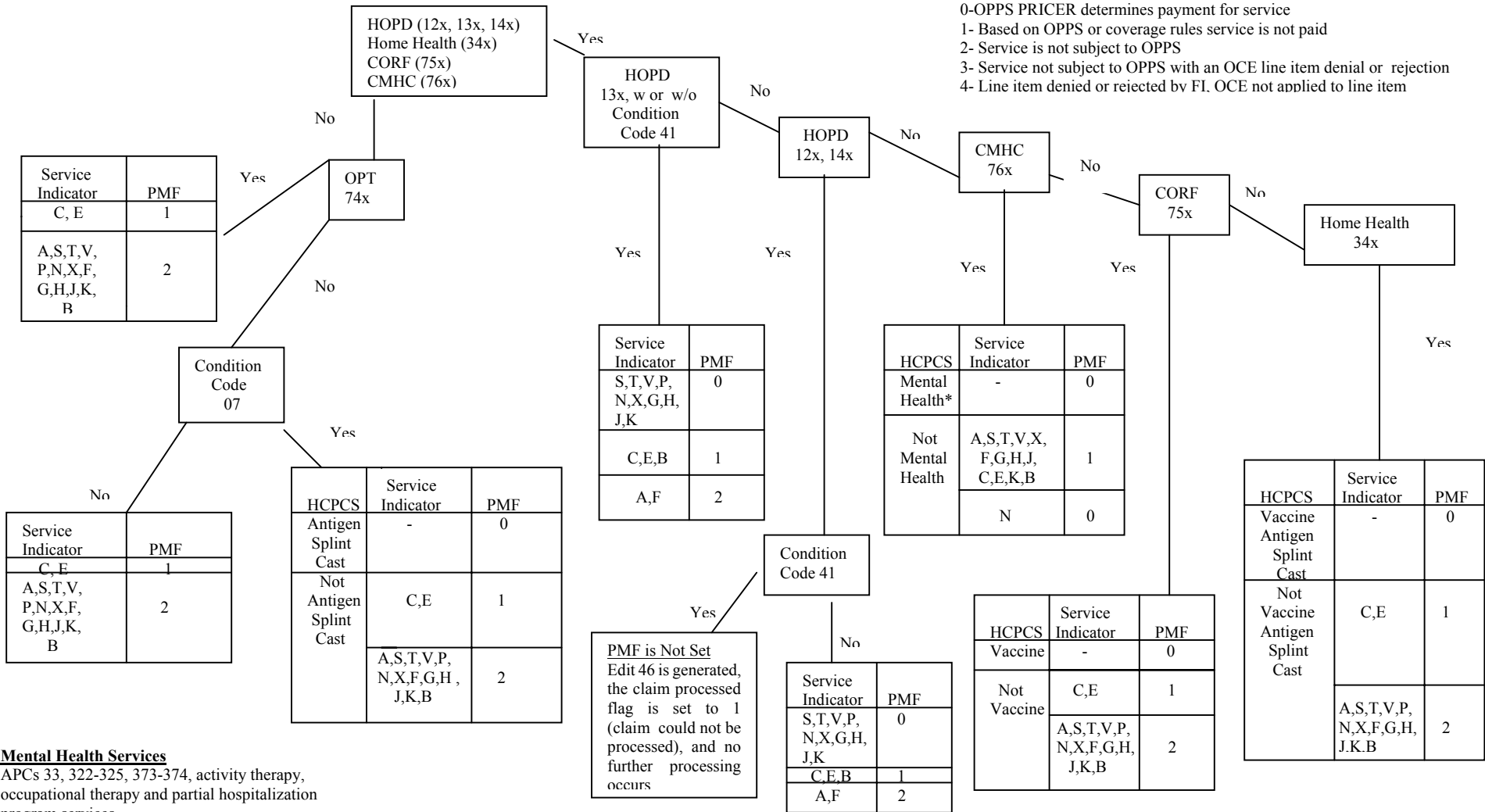

**\*Mental Health Services**

APCs 33, 322-325, 373-374, activity therapy, occupational therapy and partial hospitalization program services

1. If the claim is not processed (claim processed flag is greater than 0), the PMF is not set and is left blank.
2. If the line item denial or rejection flag is 1 or 2, and the PMF has been set to 2 by the process flowcharted here, the PMF is reset to 3.
3. If the line item actin flag is 2 or 3, the PMF is reset to 4.
4. If the line item action flag is 4, the PMF is reset to 0.
5. If PMF is set to a value greater than 0, reset HCPCS and Payment APC to 00000.
6. Service indicator J was replaced by service indicator G starting in April 2002 (V3.0)

## OCE Observation Criteria

### Assumptions

1. Separately payable observation is identified by code G0244.
2. Code G0244 has default Service Indicator 'S', and default APC 339.
3. Observation logic is performed only for claims with bill type 13x, with or without condition code 41. Lines with G0244 are rejected if the bill type is not 13x.
4. If any of the observation criteria is not met, the claim is Returned to Provider.
5. Each observation must be paired with a unique E/M or critical care (C/C) visit. E/M or C/C visit is required the day before or day of observation. If E/M is coded the same day as an S or T procedure (Observation G0244 and EKG 93005 both have SI = S), it must have modifier 25 coded also. Otherwise, Edit 21 is generated for the E/M code and it is ignored. If an observation can not be paired with an E/M or C/C visit, the claim is Returned to Provider.
6. E/M or C/C visit on the same day as observation takes precedence over E/M or C/C visit on the day before observation.
7. E/M or C/C visit or any of the qualifying services (EKG, etc.) that have been denied or rejected, either externally or by OCE edits, are ignored.
8. Both the associated E/M or C/C visit and observation are paid separately if the observation criteria are met.
9. Multiple observations on a claim are paid separately if the required criteria are met for each one.
10. If there are multiple observations within the same time period and only one meets the criteria for APC payment, the observation with the most hours is considered to have met the criteria, and the other observations will cause the claim to be Returned to Provider.
11. If there are multiple observations with the same diagnosis, each observation must have a unique set of tests performed.
12. If there are multiple observations with different diagnoses, the re-use of tests is allowed. For example, if there are two observations on the claim and both Chest Pain and CHF are coded as diagnoses, the same EKG tests will meet the requirements for both.
13. The minimum services required to qualify (e.g., EKG) must be within the dates of the E/M or C/C visit plus the first 24 hours of observation, which is presumed to span two days.
14. Observation date is assumed to be the date admitted for observation.
15. The diagnoses required for the observation criteria are:

<b>Chest Pain</b>	<b>Asthma</b>	<b>CHF</b>
411/0, 1, 81, 89	493/01, 02, 11, 12, 21, 22, 91, 92	391/8
413/0, 1, 9		398/91
786/05, 50, 51, 52, 59		402/01, 11, 91
		404/01, 03, 11, 13, 91, 93
		428/0, 1, 9, 20-23, 30-33, 40-43

16. The procedures required for the observation criteria are:

CPK	82550, 82552, 82553
Troponin	84484, 84512
EKG	93005
Peak expiratory flow rate	94010
Chest Xray	71010, 71020, 71030
Pulse Oximetry (Single, Multiple)	94760, 94761, 94762

17. The APCs required for the observation criteria to identify E/M or C/C visits are 600-602, 610-612, 620.

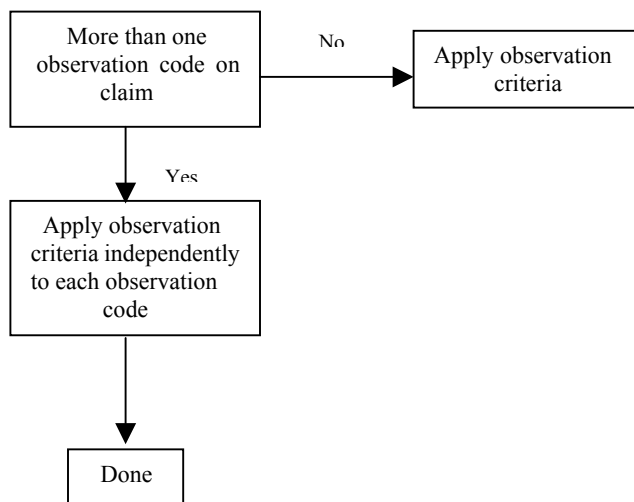
**OCE Observation Criteria (Cont.)**

### OCE Observation Criteria (Cont.)

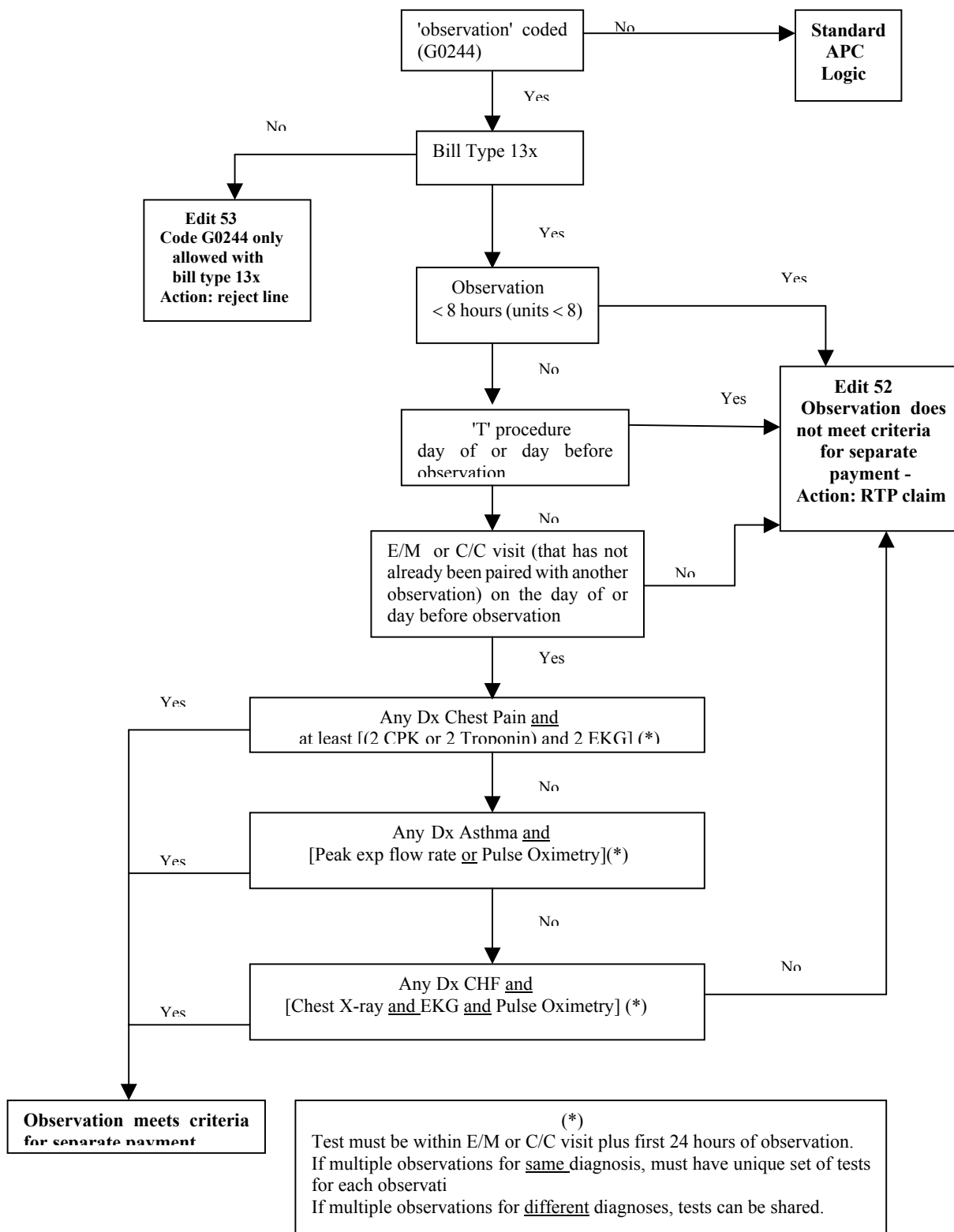

## OCE Overview

1. If claims from/through dates span more than 1 day subdivide the line items on the claim into separate days based on the calendar day of the line item service date.
2. The default values for the APC return buffer for variables not transferred from input are as follows:

Payment APC	00000
HCPCS APC	00000
Service indicator	A
Payment indicator	2
Discounting formula number	1
Line item denial or rejection flag	0
Packaging flag	0
Payment adjustment flag	0
Payment method flag	Assigned in steps 5, 13, and 14

Assign the default values to each line item in the APC return buffer.

3. If no HCPCS code is on a line item and the revenue code is from one of three specific lists, then assign the following values to the line item in the APC return buffer.

	<u>N-list</u>	<u>E-list</u>	<u>B-list</u>
HCPCS APC	00000	00000	00000
Payment APC	00000	00000	00000
Service indicator	N	E	B
Payment indicator	9	3	3
Packaging flag	1	0	0

If no HCPCS code is on a line, and the revenue center is not on the specified list, defaults will apply.

4. If applicable, based on “OCE Edits by Bill Type,” assign HCPCS APC, service indicator, and payment indicator in the APC return buffer for each line item that contains an applicable HCPCS code.
5. If edit 18 is present on a claim, generate edit 49 for all other line items occurring on the same day as the line item with edit 18, and set the line item denial or rejection flag to 1 for each of them. Go to step 12.
6. If all of the lines on the claim are incidental, and all of the line item action flags are zero, generate edit 27. Go to step 12.
7. If the line item action flag for a line item has a value of 2 or 3 then reset the values of the Payment APC to 00000, and set the payment method flag to 4. If the line item action flag for a line item has a value of 4, set the payment method flag to 0. Ignore all line items with a line item action flag of 2, 3 or 4 in all subsequent steps.
8. If bill type is 13x and condition code = 41, or type of bill = 76X, apply partial hospitalization logic from Partial Hospitalization/Mental Health Logic Charts. Go to step 10.
9. If bill type 13X without condition code 41 apply mental health logic from Partial Hospitalization/Mental Health Logic Charts independently for each date of service.
10. If bill type is 13X apply observation logic from OCE Observation Criteria below.

11. If the payment APC for a line item has not been assigned a value in steps 8 or 9 set payment APC in the APC return buffer for the line item equal to the HCPCS APC for the line item.
12. If edits 9, 13, 19, 20, 21, 39, 40, 45, 47, 49, 50, 53 are present in the edit return buffer for a line item, the line item denial or rejection flag for the line item is set to 1.
13. Compute the discounting factor based on “Computations of Discounting Factor” for each line item that has a service indicator of “T”, a modifier of 73 or 50, or is a non type “T” bilateral procedure. Line items that meet either of the following conditions are not included in the discounting logic:
  - Line item action flag is 2, 3 or 4
  - Line item rejection disposition or line item denial disposition in the APC return buffer is 1 and the line item action flag is not 1
14. If the packaging flag has not been assigned a value of 1 or 2 in previous steps and the service indicator is “N”, then set the packaging flag for the line item to 1.
15. The payment adjustment flag for a line item is set based on the criteria in Table 6.
16. The payment method flag for a line item is set based on the criteria in “Logic for Assigning Payment Method Flag Values to a Line”. If any payment method flag is set to a value that is greater than zero, reset the HCPCS and Payment APC values for that line to ‘00000’.
17. If the line item denial or rejection flag is 1 or 2 and the payment method flag has been set to 2 in step 13, reset the payment method flag to 3.



### Summary of Modifications

The modifications of the OCE/APC for the **October 2002** release (**V3.2**) are summarized in the following table. Note the redlined material in this PM, which also indicates changes.

Some OCE/APC modifications will also be retroactively added to prior OCE/APC releases. If so, the retroactive date appears in the 'Retroactive' column. Otherwise, the column is blank.

	<b>Mod. Type</b>	<b>Retro-Active</b>	<b>Edit</b>	
1.	Logic			There are no logic changes for v3.2. Edit 15 will remain turned off for this release.
2.	Logic	8/1/00		Correct error that caused payment method flag to be set to 0 instead of 2 for bill types 12X, 13X, 14X when line item had an invalid (edit 06 – RTP) code.
3.	Content			Make HCPCS/APC/SI changes, as provided by CMS.
4.	Content			Add and delete ICD-9-CM diagnoses codes to reflect CMS updates effective 10/1/02, and set appropriate edit flags as indicated by CMS.
5.	Content		19,20, 39,40	Implement version <b>8.2</b> of the NCCI file, removing all code pairs which include Anesthesia (00100-01999), E&M (92002-92014, 99201-99499), MH (90804-90911), or G0168
6.	Content			Add diagnoses 42820-23, 42830-33, 42840-43 to list of CHF codes for observation logic
7.	Content			Update the valid revenue code list to include 0681-0684, 0689
8.	Content	8/1/00		Add HCPCS code Q0091 to the list of 'deductible not applicable' codes.

**The *implementation date* of this PM is October 1, 2002.**

**The *effective date* of this PM is October 1, 2002.**

**These instructions should be implemented within your current operating budget.**

**This PM should be discarded after October 1, 2003.**

**Contractors should contact the appropriate regional office with any questions.**